

## 1. Komponenty:

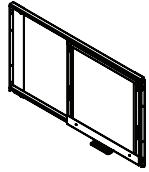

A 1ks

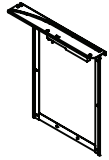

B 1ks



C 1ks

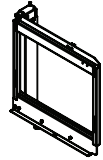

D 1ks



E 1ks

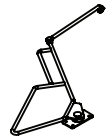

F 1ks



G 1ks



H 1ks



I 1ks

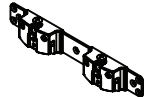

J 2ks



K 1ks



(ST4\*14)  
L 30ks



(ST4\*16)  
N 20ks



(M4\*6)  
P 4ks



(M5\*6)  
Q 4ks



(M5\*8)  
R 2ks



(M5\*18)  
T 4ks

U 2kpl

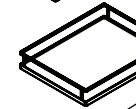
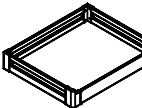
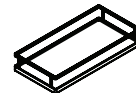
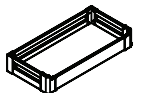

8 ks

## 2. Montáž:

① Fixing size

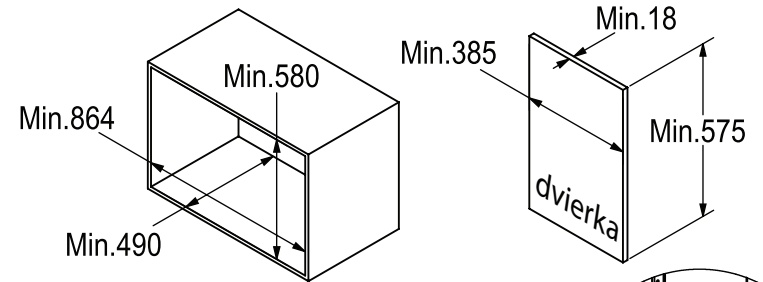

②

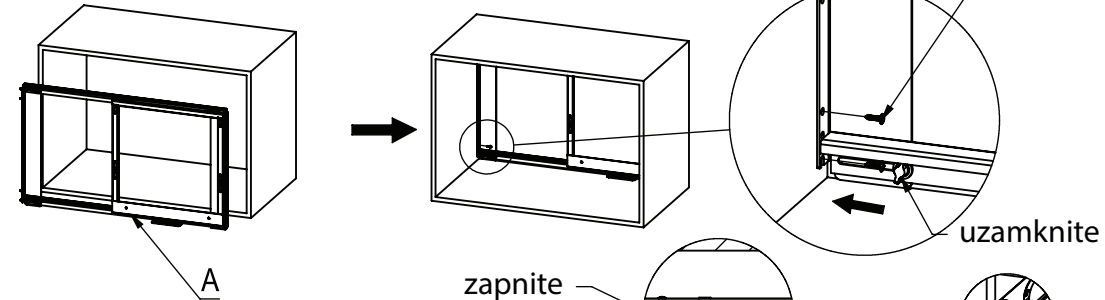

③

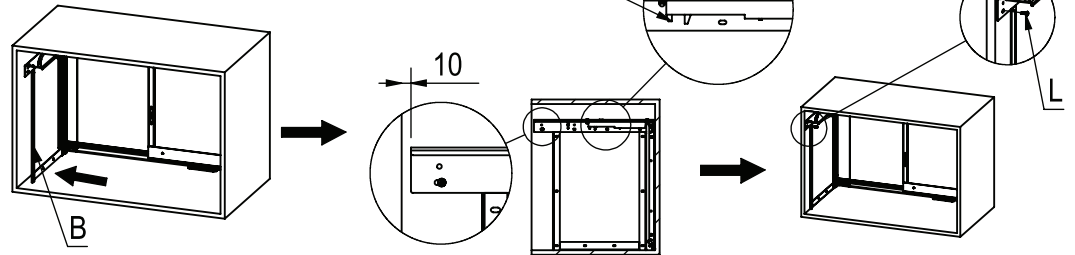

④

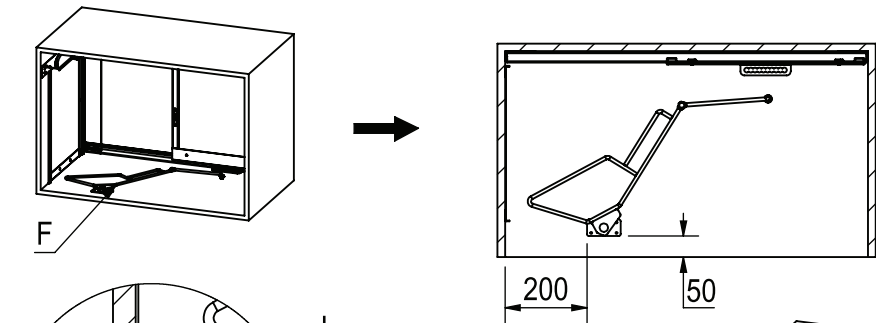

⑤

